

# **GNSS Positioning Module**

## **TAU1114**

Datasheet V1.2

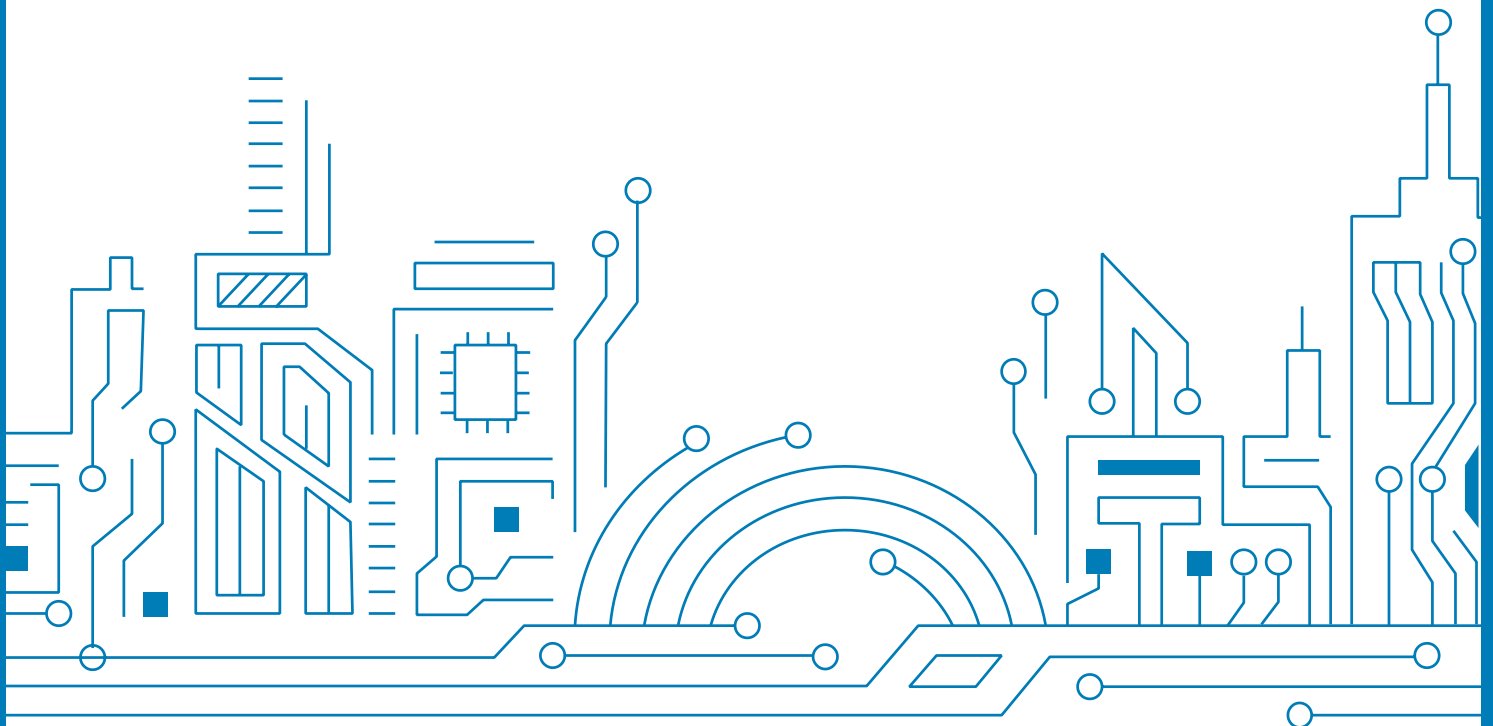

## Notice, Statement and Copyright

ALLYSTAR Technology offers this document as a service to its customers, to support application and engineering efforts that use the products designed by ALLYSTAR Technology. Products and specifications discussed herein are for reference purposes only. Performance characteristics listed in this document do not constitute a warranty or guarantee of product performance.

ALLYSTAR Technology assumes no liability or responsibility for any claims or damages arising out of the use of this document, or from the use of integrated circuits based on this document, including, but not limited to claims or damages based on infringement of patents, copyrights or other intellectual property rights.

This document contains proprietary technical information which is the property of ALLYSTAR Technology, copying of this document and giving it to others and using or communication of the contents thereof, are forbidden without express authority. Offenders are liable to the payment of damages. ALLYSTAR Technology reserves the right to make changes in its products, specifications and other information at any time without notice.

For more recent documents, please visit [www.allystar.com](http://www.allystar.com).

Copyright © Allystar Technology (Shenzhen) Co., Ltd. 2022. All rights reserved.

## About the Document

### ■ Basic info

<b>Document applies to</b>	TAU1114
<b>Document type</b>	Datasheet
<b>Revision and date</b>	V1.2/2022-08
<b>Product status</b>	Preliminary

### ■ Product status description

<b>In development</b>	Objective specification. Revision may be released in later status.
<b>Engineering sample</b>	Product specifications tested on early. Revision may be released in later status.
<b>Preliminary</b>	Product specifications come from small production. Revision may be released in later status.
<b>Mass production</b>	Final product specification to mass market.

## TABLE OF CONTENT

<b>1</b>	<b>SYSTEM OVERVIEW .....</b>	<b>7</b>
1.1	General Description .....	7
1.2	Features .....	7
1.3	Module Photo.....	8
1.4	Block Diagram.....	8
1.5	Specifications .....	9
<b>2</b>	<b>PIN DESCRIPTION .....</b>	<b>10</b>
2.1	Pin Assignment.....	10
2.2	Detailed Pin Descriptions .....	11
<b>3</b>	<b>ELECTRICAL CHARACTERISTICS .....</b>	<b>12</b>
3.1	Absolute Maximum Rating .....	12
3.2	IO Characteristics .....	12
3.2.1	PRRSTX and PRTRG .....	12
3.2.2	Others .....	12
3.3	DC Characteristics .....	13
3.3.1	Operating Conditions .....	13
3.3.2	Power Consumption.....	13
<b>4</b>	<b>HARDWARE DESCRIPTION .....</b>	<b>14</b>
4.1	Connecting Power.....	14
4.2	Antenna Design.....	14
4.3	Reset and Mode Control .....	14
<b>5</b>	<b>DEFAULT MESSAGE.....</b>	<b>16</b>
<b>6</b>	<b>MECHANICAL SPECIFICATION.....</b>	<b>17</b>
<b>7</b>	<b>REFERENCE DESIGN .....</b>	<b>18</b>
7.1	Minimal Design .....	18
7.2	PCB Footprint Reference .....	19
7.3	Layout Notes .....	19
<b>8</b>	<b>SOFTWARE INTERFACE .....</b>	<b>20</b>
8.1	NMEA Message Format.....	20
8.1.1	GGA - Global Positioning System Fix Data.....	20
8.1.2	GLL - Geographic Position - Latitude/Longitude .....	21
8.1.3	GSA - GNSS DOP and Active Satellites.....	21
8.1.4	GSV - GNSS Satellites in View.....	22
8.1.5	RMC - Recommended Minimum Specific GNSS Data.....	23

8.1.6	VTG - Course over Ground and Ground Speed.....	24
8.1.7	ZDA - Time & Date.....	24
8.1.8	GST - GNSS Pseudorange Error Statistics.....	24
8.1.9	TXT - ANT & USR message.....	25
8.2	Exclusive Binary Message.....	26
8.3	Mode Configuration.....	26
8.3.1	CFG-SIMPLERST.....	26
<b>9</b>	<b>PRODUCT PACKAGING AND HANDLING.....</b>	<b>28</b>
9.1	Packaging.....	28
9.1.1	Packaging Notes.....	28
9.1.2	Tape and Reel.....	28
9.1.3	Shipment Packaging.....	29
9.2	Storage.....	30
9.3	Handling.....	30
9.3.1	ESD Handling Precautions.....	30
9.3.2	ESD Protection Measures.....	30
9.3.3	Moisture Sensitivity Level.....	30
<b>10</b>	<b>LABELING AND ORDERING INFORMATION.....</b>	<b>31</b>
10.1	Labeling.....	31
10.2	Ordering info.....	31
<b>11</b>	<b>RELATED DOCUMENTS.....</b>	<b>32</b>
<b>12</b>	<b>REVISION HISTORY.....</b>	<b>32</b>

## List of tables

Table 1	TAU1114.....	7
Table 2	Specifications.....	9
Table 3	Time To First Fix (TTFF).....	10
Table 4	Detailed pin descriptions.....	11
Table 5	Absolute rating.....	12
Table 6	PRRSTX and PRTRG.....	12
Table 7	Others.....	12
Table 8	Operating conditions.....	13
Table 9	Power consumption.....	13
Table 10	Default messages.....	16
Table 11	Dimensions.....	17
Table 12	NMEA output message.....	20
Table 13	GGA Data Format.....	20
Table 14	Position Fix Indicators.....	21
Table 15	GLL Data Format.....	21

Table 16 GSA Data Format .....	21
Table 17 Mode 1 .....	22
Table 18 Mode 2.....	22
Table 19 GSV Data Format .....	22
Table 20 RMC Data Format .....	23
Table 21 VTG Data Format .....	24
Table 22 ZDA Data Format .....	24
Table 23 GST Data Format .....	25
Table 24 TXT Data Format .....	25
Table 25 Antenna status NMEA output .....	25
Table 26 Commands exclusive to TAU1114 .....	26
Table 27 Packing hierarchy .....	28
Table 28 Ordering codes.....	31

## List of figures

Figure 1 TAU1114 module .....	8
Figure 2 Block diagram.....	8
Figure 3 Pin assignment (top view) .....	10
Figure 4 Timing of mode entry with host controller .....	15
Figure 5 Dimensions .....	17
Figure 6 TAU1114-1216A00.....	18
Figure 7 PCB Footprint Reference.....	19
Figure 8 Tape dimensions .....	28
Figure 9 Reel dimensions .....	29
Figure 10 Packaging .....	29

# 1 SYSTEM OVERVIEW

## 1.1 General Description

TAU1114 is a cost-effective GNSS positioning module based on HD812X GNSS chip supporting GPS/QZSS, BDS, Galileo, GLONASS and SBAS at a low current consumption. It is a versatile module that features SAW, LNA, flash memory as well as an antenna supervisor and can be used with active and passive antennas.

TAU1114 is fit for a wide range of applications in tracking, telematics, and navigation. It is pin compatible with its predecessors TAU1102 and TAU1111 as well as many mainstream GNSS modules, making it the perfect choice to upgrade existing design, be it for a lower power consumption or to avoid excessive lead times.

## 1.2 Features

- Versatile GNSS module supporting GPS/QZSS, BDS, Galileo, GLONASS and SBAS
- Low current consumption of only 15 mA for GPS/QZSS
- Active and passive antennas supported thanks to built-in SAW and LNA
- Supports Allystar's free-of-charge A-GNSS service for minimal startup times
- Pin-compatible with previous generation TAU1102, TAU1111 and many mainstream GNSS modules

**Table 1 TAU1114**

Product	GNSS								Feature				Interface			Accuracy		Grade				
	GNSS system mode	Band (S/D/T)	GPS/QZSS	BDS	GLONASS	Galileo	NavIC	SBAS	Built-in LNA	Programmable (flash)	Data logging	D-GNSS	Oscillator	UART	I2C	USB	SPI	Meter	Sub-meter	Centimeter	Industrial	Automotive
TAU1114-1216A00E	01	S	•		•			•	•	•	•	T	•				•				•	
	02	S	•		•	•		•	•	•	•	T	•				•				•	
	03	S	•	•		•		•	•	•	•	T	•				•				•	

T = TCXO

### 1.3 Module Photo



Figure 1 TAU1114 module

### 1.4 Block Diagram

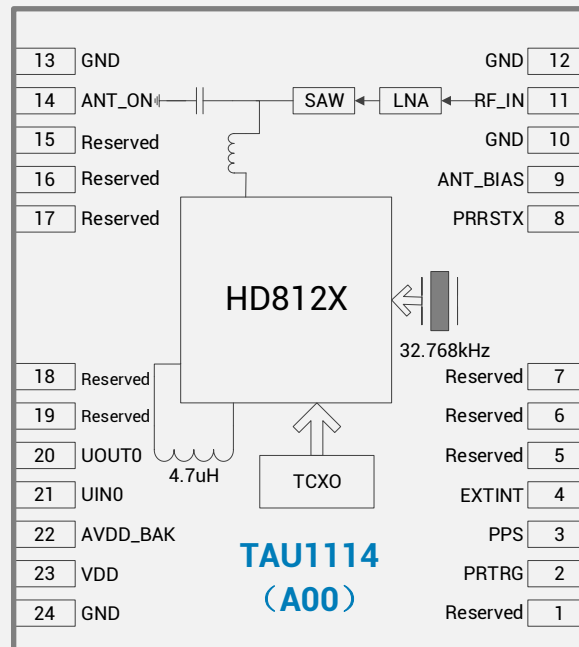

Figure 2 Block diagram



## 1.5 Specifications

**Table 2 Specifications**

Parameter	Specification		
GNSS channels	88 in total		
GNSS reception	GPS/QZSS: L1C/A		
	GLONASS: G1		
	Galileo: E1		
	BDS: B1I		
	SBAS: L1 (SDCM, WAAS, EGNOS, GAGAN and MSAS)		
Updating rate	5 Hz maximum		
Position accuracy <sup>[1]</sup>	GNSS	1.5m CEP	
	GNSS (with SBAS)	< 1.0m CEP	
Velocity & Time accuracy	GNSS	0.1 m/s CEP	
	PPS_1 $\sigma$	20 ns	
Sensitivity <sup>[2]</sup>	Cold start	-148 dBm	
	Hot start	-156 dBm	
	Reacquisition	-158 dBm	
	Tracking	-163 dBm	
Operating condition	Main voltage	2.0-3.63 V	
	Digital I/O voltage	2.0-3.63 V	
	Backup voltage	1.62-3.63 V	
Power consumption	Tracking	GPS/QZSS+Galileo+GLONASS+SBAS	20 mA @ 3.3V
		GPS/QZSS+GLONASS+SBAS	20 mA @ 3.3V
		GPS/QZSS+Galileo+BDS+SBAS	16 mA @ 3.3V
		GPS/QZSS	15 mA @ 3.3V
	Acquisition	GPS/QZSS+Galileo+GLONASS+SBAS	20 mA @ 3.3V
		GPS/QZSS+GLONASS+SBAS	21 mA @ 3.3V
		GPS/QZSS+Galileo+BDS+SBAS	17 mA @ 3.3V
		GPS/QZSS	15 mA @ 3.3V
Standby mode	15 uA @ 3.3V		
Serial interface	UART	1	
Protocol	NMEA 0183 Protocol Ver.3.01/4.00/4.10 (Default) Cynosure GNSS Receiver Protocol		
Operating limit	Velocity	515 m/s	
	Altitude	18,000m	
Antenna supervision	Antenna short circuit protection and open circuit detection		
Operating temperature	-40°C to +85°C		
Storage temperature	-40°C to +85°C		
Package	12.2x16.0x2.4 mm 24-pin LLC		
Certification	RoHS, REACH, FCC, CE-RED		

\* [1] Open sky condition.

\* [2] Demonstrated with a good external LNA

**Table 3 Time To First Fix (TTFF)**

Parameter	GPS/QZSS+Galileo+GLONASS+SBAS	GPS/QZSS+GLONASS+SBAS	GPS/QZSS+Galileo+BDS+SBAS	GPS/QZSS
Hot start	2s	2s	2s	1s
Cold start	26s	28s	28s	28s

## 2 PIN DESCRIPTION

### 2.1 Pin Assignment

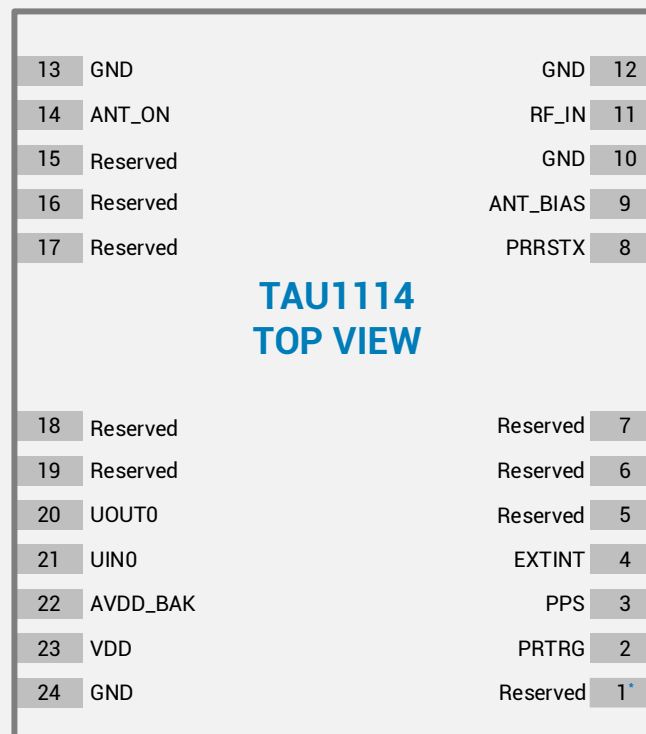
**Figure 3 Pin assignment (top view)**

\* Pin 1 aligns to the circular hole on module cover.

## 2.2 Detailed Pin Descriptions

**Table 4 Detailed pin descriptions**

Function	Symbol	No.	I/O	Description
Power	VDD	23	Power	Main power supply voltage input.
	GND	10, 12, 13, 24	VSS	Assure a good GND connection to all GND pins of the module, preferably with a large ground plane.
	AVDD_BAK	22	Power	Backup power supply voltage input.
Antenna	RF_IN	11	I	RF signal input. Use a controlled impedance of 50 $\Omega$ for the routing from RF_IN pin to the antenna or the antenna connector.
	ANT_BIAS	9	O	Antenna bias voltage output. The ANT_BIAS pin can be used to power an external active antenna, and the current should be no more than 25 mA.
UART	UOUT0	20	O	UART serial data output.
	UIN0	21	I	UART serial data input.
Other	PRTRG	2	I	Mode selection, or the trigger input in deep sleep mode to wake up the system.
	PRRSTX	8	I	External reset, low active
	PPS	3	O	Setting for time pulse output (PPS). Leave it floating if not used.
	EXTINT	4	I	A trigger pin to external interrupt. Leave it floating if not used.
	ANT_ON	14	O	A trigger pin to enable external antenna output. Leave it floating if not used.
	Reserved	1, 5, 6, 7, 15, 16, 17, 18, 19	-	Reserved. Leave it floating if not used.

## 3 ELECTRICAL CHARACTERISTICS

### 3.1 Absolute Maximum Rating

Table 5 Absolute rating

Symbol	Parameter	Min.	Max.	Unit
VDD	Power input for the main power domain	-0.5	3.63	V
AVDD_BAK	Power input for the backup power domain	-0.5	3.63	V
V <sub>I</sub> max	Digital I/O pin input voltage	-0.5	3.6	V
T <sub>storage</sub>	Storage temperature	-40	85	°C
T <sub>solder</sub>	Solder reflow temperature	--	260	°C
VESD (HBM)	Maximum tolerable ESD level	--	2000	V

### 3.2 IO Characteristics

#### 3.2.1 PRRSTX and PRTRG

Table 6 PRRSTX and PRTRG

Symbol	Parameter	Condition	Min.	Typ.	Max.	Unit
I <sub>Iz</sub>	Input leakage current	--	--	--	+/-1	uA
V <sub>IH</sub>	Input high voltage	--	AVDD_BAK* 0.67	--	AVDD_BAK	V
V <sub>IL</sub>	Input low voltage	--	0	--	AVDD_BAK*0.27	V
V <sub>OH</sub>	Output high voltage	I <sub>OH</sub> = 5.3 mA, AVDD_BAK = 3.3V	2.64	--	--	V
		I <sub>OH</sub> = 1.2 mA, AVDD_BAK = 1.8V	1.53	--	--	V
V <sub>OL</sub>	Output low voltage	I <sub>OL</sub> = 3.9 mA, AVDD_BAK = 3.3V	--	--	0.4	V
		I <sub>OL</sub> = 1.9 mA, AVDD_BAK = 1.8V	--	--	0.45	V
C <sub>i</sub>	Input capacitance	--	--	--	11	pF
R <sub>PU</sub>	Pull-up resistance	--	35	--	84	kΩ

#### 3.2.2 Others

Table 7 Others

Symbol	Parameter	Condition	Min.	Typ.	Max.	Unit
I <sub>Iz</sub>	Input leakage current	--	--	--	+/-1	uA
V <sub>IH</sub>	Input high voltage	--	VDD*0.67	--	VDD	V
V <sub>IL</sub>	Input low voltage	--	0	--	VDD*0.27	V
V <sub>OH</sub>	Output high voltage	I <sub>OH</sub> = 5.3 mA, VDD = 3.3V	2.64	--	--	V

V <sub>OL</sub>	Output low voltage	I <sub>OL</sub> = 3.9 mA, VDD = 3.3V	--	--	0.4	V
C <sub>i</sub>	Input capacitance	--	--	--	11	pF
R <sub>PU</sub>	Pull-up resistance	--	35	--	84	kΩ

### 3.3 DC Characteristics

#### 3.3.1 Operating Conditions

**Table 8 Operating conditions**

Symbol	Parameter	Min.	Typ.	Max.	Unit
VDD	Power supply voltage	2.0	3.3	3.63	V
AVDD_BAK	Backup battery voltage	1.62	3.3	3.63	V
ICC <sub>max</sub>	Maximum operating current @ VDD	--	--	200	mA
T <sub>env</sub>	Operating temperature	-40	--	85	°C
V <sub>ANT_BIAS</sub>	Antenna bias voltage	--	VDD-0.15 <sup>[1]</sup>	--	V

\* [1] Condition: tested at high, low, and room temperature, with 0.1V deviation.

#### 3.3.2 Power Consumption

**Table 9 Power consumption**

Parameter	Measure Pin	Typ.	Unit
Tracking	VDD <sup>[1]</sup>	20	mA
		20	
		16	
		15	
Acquisition	VDD <sup>[1]</sup>	20	mA
		21	
		17	
		15	
Standby mode	AVDD_BAK <sup>[2]</sup>	15	uA

\* [1] Condition: VDD = 3.3V @ Room Temperature. All Pins Open.

\* [2] Condition: AVDD\_BAK = 3.3V @ Room Temperature. All Pins Open.

## 4 HARDWARE DESCRIPTION

### 4.1 Connecting Power

In order to ensure the positioning performance, please control the ripple of the module power supply. It is recommended to use the LDO with max output current above 100 mA.

If the power for VDD pin is off, the real-time clock (RTC) and battery backed RAM (BBR) are supplied through the AVDD\_BAK pin. Thus, orbit information and time can be maintained and will allow a Hot or Warm start.

**Note:** If no backup supply is available, connect the AVDD\_BAK pin to VDD or leave it floating.

### 4.2 Antenna Design

There is a built-in LNA and SAW in the GNSS module. It is recommended to use either a passive or an active antenna with gain less than 30 dB.

The module has built-in short circuit protection and open circuit detection functions, which can detect the antenna status of normal connection, open circuit, and short circuit, and send out the status prompt message in NMEA data.

- **Short circuit protection**
  - » The module includes internal short circuit antenna detection. Once an overcurrent is detected at the ANT\_BIAS port, the module will cut off this power supply automatically to prevent permanent damages.
- **Open circuit detection**
  - » The module can detect an open circuit in the antenna. Users can judge it from antenna status messages.

### 4.3 Reset and Mode Control

The operation mode of GNSS module is controlled by PRRSTX (nRESET) and PRTRG (BOOT) pin. PRTRG pin cannot work alone when the module operates normally. PRRSTX pin can reset the system. Users **MUST** retain PRTRG and PRRSTX pins in the design to ensure that the Boot mode is accessible in case that there is no firmware written in the embedded chip.

- Keep PRTRG pin floating during system power-up or the external reset (PRRSTX from low to high), and the module will enter **User Normal Mode**.
- When the module powers up or PRRSTX from low to high, the module will execute an **external reset**. (If the power for AVDD\_BAK is always on, the external reset will not affect the ephemeris data in the backup domain)
- Drive PRTRG pin to low or connect PRTRG to GND directly (not by pull-down resistance) during system power-up or the external reset (PRRSTX from low to high), and the system enters **BootROM Command Mode** at PRTRG pin being released from low to floating state, and ready for firmware upgrading command.

- When connecting PRRSTX and PRTRG to any host IO, DO NOT use the pull-up or pull-down resistance.

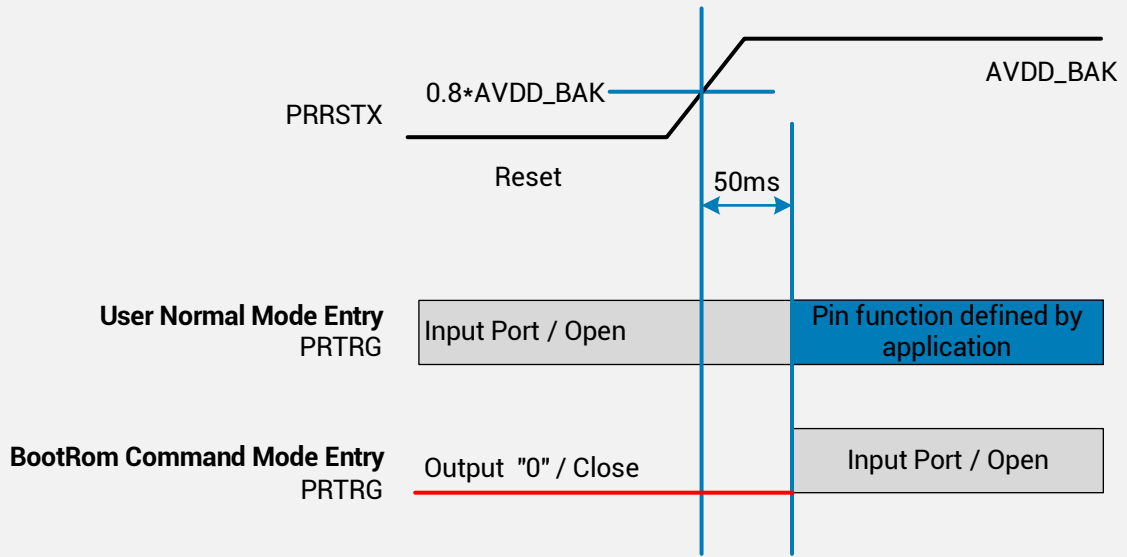

Figure 4 Timing of mode entry with host controller

## 5 DEFAULT MESSAGE

**Table 10 Default messages**

Interface	Settings
UART output	9600 baud, 8 data bits, no parity bit, 1 stop bit. Configured to transmit both NMEA and HD Binary protocols, but only the following NMEA (and no HD Binary sentence) messages have been activated at start-up: GGA, GSA, GSV, RMC, ZDA, TXT-ANT
UART input	9600 baud, 8 data bits, no parity bit, 1 stop bit, autobauding disabled. Automatically accepts the following protocols without need of explicit configuration: HD binary sentence, NMEA The GNSS receiver supports interleaved HD Binary and NMEA messages.
Timepulse (1 Hz Nav)	1 pulse per second, synchronized at rising edge, pulse length 100 ms.

\* Refer to *GNSS\_Protocol\_Specification* for information about other settings.

When the module is applied to the specific application, users can shut off the main power in order to further reduce the power consumption. To avoid the high level in serial interface influencing the normal operation, it is highly suggested to cut off the serial port when shut off the main power. Otherwise, please set the serial port to input mode or high impedance state with pull-down resistor.



## 6 MECHANICAL SPECIFICATION

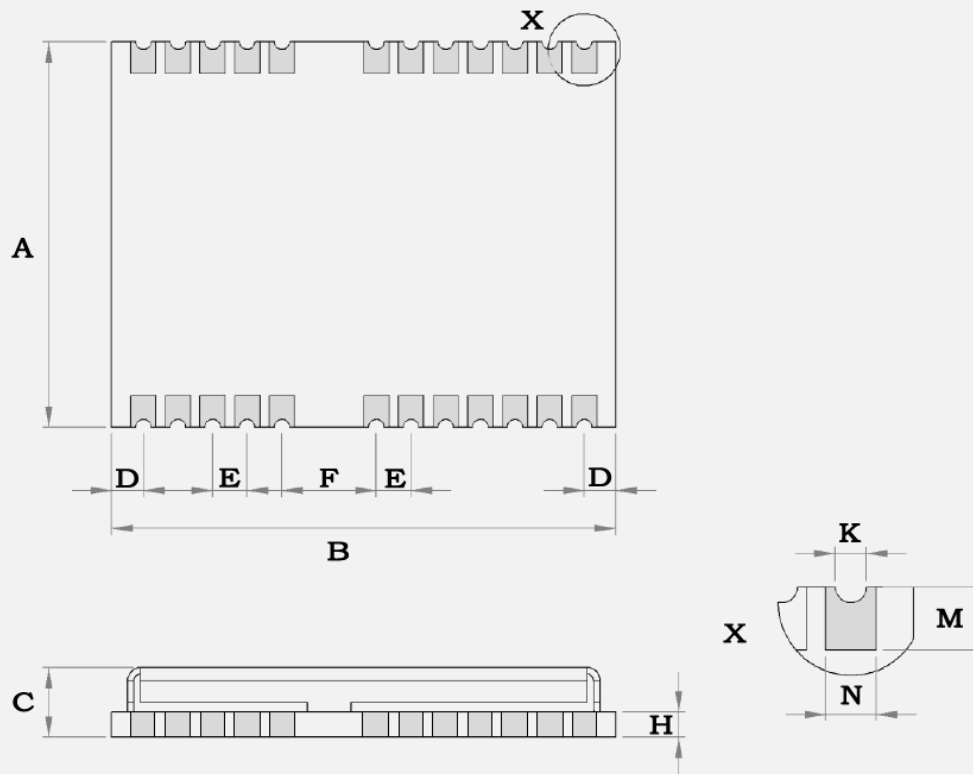

**Figure 5 Dimensions**

**Table 11 Dimensions**

Symbol	Min. (mm)	Typ.(mm)	Max. (mm)
A	12.0	12.2	12.4
B	15.8	16.0	16.2
C	2.2	2.4	2.6
D	0.9	1.0	1.3
E	1.0	1.1	1.2
F	2.9	3.0	3.1
H	--	0.8	--
K	0.4	0.5	0.6
M	0.8	0.9	1.0
N	0.7	0.8	0.9

## 7 REFERENCE DESIGN

### 7.1 Minimal Design

The minimal design of TAU1114 shows as below. The 82 nH inductor is used only when an active antenna is connected, and no need with a passive antenna. The characteristic impedance from RF\_IN pin to the antenna connector should be 50Ω.

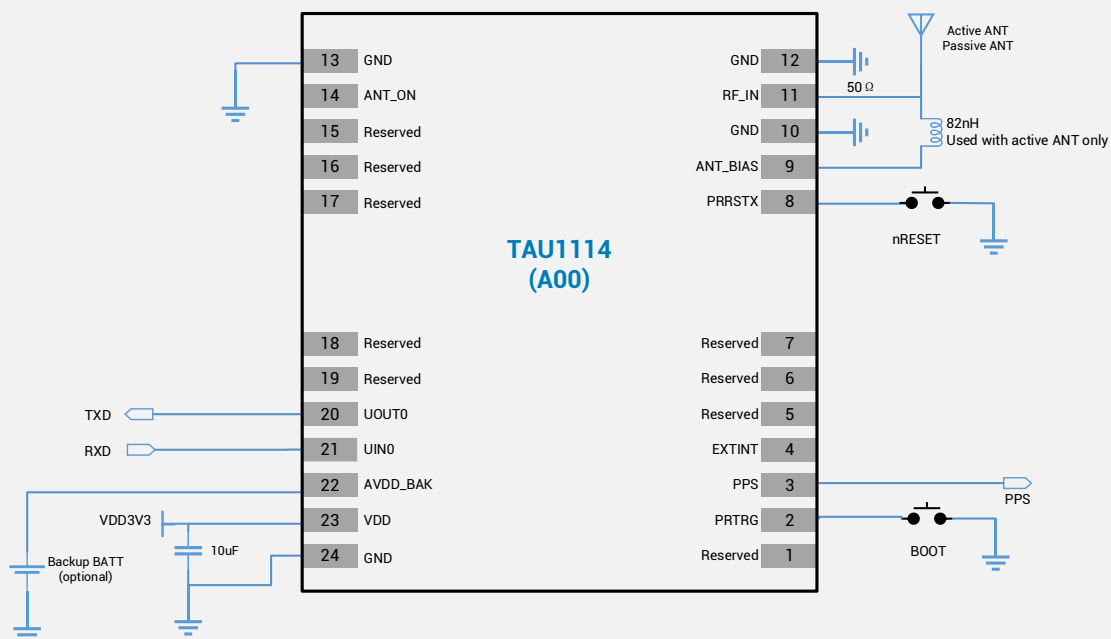

Figure 6 TAU1114-1216A00

## 7.2 PCB Footprint Reference

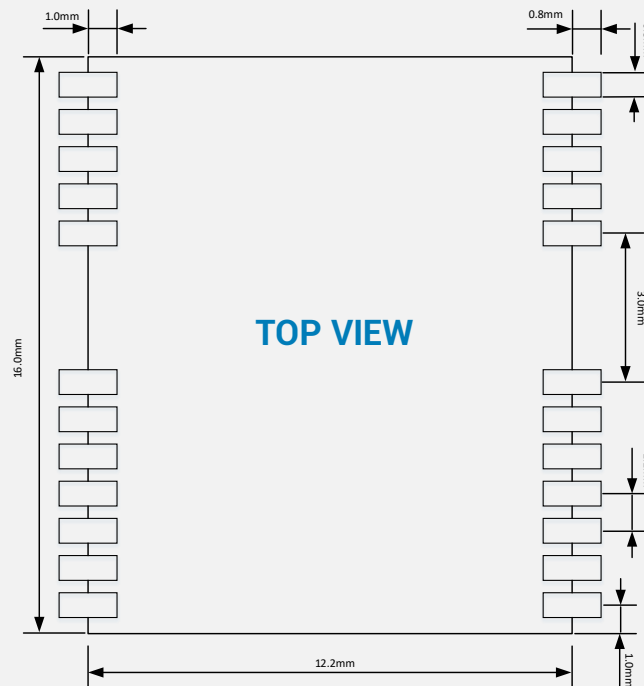

Figure 7 PCB Footprint Reference

## 7.3 Layout Notes

- (1) A decoupling capacitor should be placed close to VDD pin of the module, and the width of power routing should be more than 0.5 mm.
- (2) The width of RF routing between RF port to antenna interface should be wider than 0.2 mm. The characteristic impedance of RF routing between RF port to antenna interface should be controlled to 50Ω.
- (3) It is recommended that the routing from RF port to antenna interface refers to the second layer, and no routing are recommended on the layer.
- (4) Do not place the module close to any EMI source, like antenna, RF routing, DC/DC or power conductor, clock signal or other high-frequency switching signal, etc.

## 8 SOFTWARE INTERFACE

### 8.1 NMEA Message Format

Table 12 NMEA output message

NMEA	Sub ID	Description
GGA	0x00	Global positioning system fixed data
GLL	0x01	Geographic position - latitude/longitude
GRS	0x02	GNSS range residuals
GSA	0x03	GNSS Overall satellite data
GSV	0x04	GNSS Detailed satellite data
RMC	0x05	Recommended minimal data for GNSS
VTG	0x06	Course over ground and ground speed
ZDA	0x07	Date and time
GST	0x08	GNSS Pseudorange Error Statistics
TXT	0x20	Antenna status

\* The default output of module is GGA, GSA, GSV, RMC, ZDA, and TXT.

#### 8.1.1 GGA - Global Positioning System Fix Data

Output example of Table 13 shows as below:

```
$GNGGA,074144.000,3957.79941,N,11619.02981,E,1,19,0.83,105.5,M,-8.4,M,,*65
```

Table 13 GGA Data Format

Name	Example	Unit	Description
Message ID	\$GNGGA		GGA protocol header
UTC Time	074144.000		hhmmss.sss
Latitude	3957.79941		ddmm.mmmmm
N/S indicator	N		N = north or S = south
Longitude	11619.02981		dddmm.mmmmm
E/W Indicator	E		E = east or W = west
Position Fix Indicator	1		See Table 14
Satellites Used	19		Number of satellites in use, 00-24
HDOP	0.83		Horizontal Dilution of Precision (meters)
MSL Altitude	105.5	meters	Antenna Altitude above/below mean-sea-level (geoid) (in meters)
Units	M	meters	Units of antenna altitude, meters
Geoidal Separation	-8.4	meters	
Units	M	meters	Units of geoidal separation, meters
Age of diff. GNSS data		second	Null fields when DGPS is not used

Diff. Ref. Station ID			Differential reference station ID, 0000-1023
Checksum	*65		Checksum
<CR> <LF>			End of message termination

**Table 14 Position Fix Indicators**

Value	Description
0	Fix not available
1	GNSS fix
2	Differential GNSS fix

### 8.1.2 GLL - Geographic Position - Latitude/Longitude

Output example of Table 15 shows as below:

```
$GNGLL,2503.71465,N,12138.73922,E,062052.000,A,A*45
```

**Table 15 GLL Data Format**

Name	Example	Unit	Description
Message ID	\$GNGLL		GLL protocol header
Latitude	2503.71465		ddmm.mmmmm
N/S indicator	N		N = north or S = south
Longitude	12138.73922		dddmm.mmmmm
E/W indicator	E		E = east or W = west
UTC Time	062052.000		hhmmss.sss
Status	A		A = data valid or V = data not valid
Mode	A		A = Autonomous, D = DGPS, N = Data not valid,
Checksum	*45		
<CR> <LF>			End of message termination

### 8.1.3 GSA - GNSS DOP and Active Satellites

Output example of Table 16 shows as below:

```
$GPGSA,A,3,01,11,18,30,28,07,17,22,03,,,,,1.10,0.79,0.77,1*12
```

```
$BDGSA,A,3,10,07,08,12,03,13,01,11,02,04,05,,1.10,0.79,0.77,4*0B
```

**Table 16 GSA Data Format**

Name	Example	Unit	Description
Message ID	\$GPGSA		GSA protocol header
Mode 1	A		See Table 17
Mode 2	3		See Table 18
ID of satellite used	01		Sv on Channel 1
ID of satellite used	11		Sv on Channel 2
....			....

ID of satellite used			Sv on Channel 12
PDOP	1.10		Position Dilution of Precision
HDOP	0.79		Horizontal Dilution of Precision
VDOP	0.77		Vertical Dilution of Precision
System ID	1		Satellites used in GPS 1 = GPS 4 = BD
Checksum	*12		
<CR> <LF>			End of message termination

**Table 17 Mode 1**

Value	Description
M	Manual - forced to operate in 2D or 3D mode
A	Automatic - allowed to automatically switch 2D/3D

**Table 18 Mode 2**

Value	Description
1	Fix not available
2	2D
3	3D

#### 8.1.4 GSV - GNSS Satellites in View

Output example of Table 19 shows as below:

\$GPGSV,4,1,15,193,69,35,39,6,50,28,41,137,50,134,34,129,50,134,34\*73

\$GPGSV,4,2,15,17,45,137,41,2,42,326,40,5,42,250,40,128,38,243,36\*4B

\$GPGSV,4,3,15,9,36,65,42,12,26,285,35,127,12,260,32,19,9,137,35\*7D

\$GPGSV,4,4,15,23,8,41,35,25,4,316,36,28,,,\*4F

\$BDGSV,3,1,09,8,75,64,39,6,73,237,38,3,58,205,38,1,53,143,38\*56

\$BDGSV,3,2,09,9,47,224,38,4,38,118,37,2,35,246,33,5,16,259,31\*6C

\$BDGSV,3,3,09,10,2,210,21\*62

**Table 19 GSV Data Format**

Name	Example	Unit	Description
Message ID	\$GPGSV		GSV protocol header
Total number of messages <sup>[1]</sup>	4		Range 1 to 6, Total number of GSV messages to be transmitted in this group
Message number <sup>[1]</sup>	1		Range 1 to 6 Origin number of this GSV message within current group

Satellites in view	15		Total number of satellites in view
Satellite ID <sup>[2]</sup>	193		Satellite PRN number
Elevation	69	degrees	Elevation in degrees (Range 00 to 90)
Azimuth	35	degrees	Azimuth in degrees to true north (Range 000 to 359)
SNR (C/No)	39	dB-Hz	SNR in dB (Range 00 to 99, null when not tracking)
...			....
Satellite ID	129		Satellite PRN number (Range 01 to 196)
Elevation	50	degrees	Elevation in degrees (Range 00 to 90)
Azimuth	134	degrees	Azimuth in degrees to true north (Range 000 to 359)
SNR (C/No)	34	dB-Hz	SNR in dB Channel 4 (Range 00 to 99, null when not tracking)
Checksum	*73		
<CR> <LF>			End of message termination

\* [1]: Depending on the number of satellites tracked multiple messages of GSV data may be required.

\* [2]: GPS ID: 01~32, SBAS ID: 127~141, QZSS ID: 193~199, BeiDou ID: 01~32

### 8.1.5 RMC - Recommended Minimum Specific GNSS Data

Output example of Table 20 shows as below:

```
$GNRMC,075939.000,A,2225.56166,N,11412.68199,E,0.000,64.79,020589,0.0,E,A*1D
```

```
$GNRMC,074458.000,A,3957.79932,N,11619.03010,E,0.005,0.00,280419,,A*4B
```

**Table 20 RMC Data Format**

Name	Example	Unit	Description
Message ID	\$GNRMC		RMC protocol header
UTC Time	075939.000		hhmmss.sss
Status	A		A = data valid or V = data not valid
Latitude	2225.56166		ddmm.mmmmm
N/S Indicator	N		N = north or S = south
Longitude	11412.68199		dddmm.mmmmm
E/W Indicator	E		E = east or W = west
Speed over ground	0.000	knots	Speed over ground
Course over ground	64.79	degrees	Degrees to true north
Date	020589		ddmmyy
Magnetic variation	0.0	degrees	(Not shown)
Variation sense	E		E = east or W = west (Not shown)
Mode	A		A = Autonomous, D = DGPS, N = Data not valid,
Checksum	*4B		
<CR> <LF>			End of message termination

### 8.1.6 VTG - Course over Ground and Ground Speed

Output example of Table 21 shows as below:

```
$GNVTG,0.00,T,0.00,M,0.000,N,0.000,K,A*3D
```

```
$GNVTG,0.00,T,,M,0.011,N,0.021,K,A*20
```

**Table 21 VTG Data Format**

Name	Example	Unit	Description
Message ID	\$GNVTG		VTG protocol header
Course over ground	0.00	degrees	Degrees to true north
Reference	T		True north
Course over ground		degrees	Degrees to Magnetic
Reference	M		Magnetic
Speed over ground	0.000	knots	Measured speed
Units	N		Knots
Speed over ground	0.000	km/hr	Measured speed
Units	K		Kilometer per hour
Mode	A		A = Autonomous, D = DGPS, N = Data not valid,
Checksum	*3D		
<CR> <LF>			End of message termination

### 8.1.7 ZDA - Time & Date

Output example of Table 22 shows as below:

```
$GNZDA,033900.000,28,10,2015,,*4C
```

**Table 22 ZDA Data Format**

Name	Example	Unit	Description
Message ID	\$GNZDA		ZDA protocol header
UTC Time	033900.000		hhmmss.sss
Day	28		dd (01 to 31)
Month	10		mm (01 to 12)
Year	2015		yyyy (1980 to 2025)
Local zone hours		hour	
Local zone minutes		minute	
Checksum	*4C		
<CR> <LF>			End of message termination

### 8.1.8 GST - GNSS Pseudorange Error Statistics

Output example of Table 23 shows as below:

```
$GNGST,081119.000,1.2,,,,0.6,0.5,0.5*52
```



**Table 23 GST Data Format**

Name	Example	Unit	Description
Message ID	\$GNGST		GST protocol header
UTC Time	081119.000		hhmmss.sss
RMS value	1.2		RMS value of the standard deviation of the range inputs to the navigation process. Range inputs include pseudoranges & DGNSS corrections
Standard semi-major axis of error		Meter	Standard deviation of semi-major axis of error ellipse
Standard semi-minor axis of error		Meter	Standard deviation of semi-minor axis of error ellipse
Orientation of semi-major axis of error		Degree	Orientation of semi-major axis of error ellipse (degrees from true north)
latitude error	0.6	Meter	Standard deviation of latitude error
longitude error	0.5	Meter	Standard deviation of longitude error
altitude error	0.5	Meter	Standard deviation of altitude error
Checksum	*52		

### 8.1.9 TXT - ANT & USR message

Output example of Table 24 shows as below:

```
$GNTXT,01,01,01,ANT_OK*50
```

**Table 24 TXT Data Format**

Name	Example	Unit	Description
Message ID	\$GNTXT		USR message protocol header
Total number	01		Total number of sentences
Sentence Number	01		Sentence number
Identifier	01		Text identifier
Content	ANT_OK		Text message
Checksum	*50	4C	
<CR> <LF>			End of message termination

**Table 25 Antenna status NMEA output**

Active antenna status	GNSS module output
Short circuit	\$GNTXT,01,01,01,ANT_SHORT*06
Normal operating	\$GNTXT,01,01,01,ANT_OK*50
Open circuit	\$GNTXT,01,01,01,ANT_OPEN*40

## 8.2 Exclusive Binary Message

The common exclusive commands show as below:

**Table 26 Commands exclusive to TAU1114**

Command description	Software command <sup>[2]</sup>
Perform a Cold start	F1 D9 06 40 01 00 01 48 22
Perform a Warm start	F1 D9 06 40 01 00 02 49 23
Perform a Hot start	F1 D9 06 40 01 00 03 4A 24
Perform a Factory reset	F1 D9 06 09 08 00 02 00 00 00 FF FF FF FF 15 01
UART configures as 115200 bps	F1 D9 06 00 08 00 00 00 00 00 C2 01 00 D1 E0
UART configures as 9600 bps	F1 D9 06 00 08 00 00 00 00 00 80 25 00 00 B3 07
Enable ZDA message	F1 D9 06 01 03 00 F0 07 01 02 1E
Disable ZDA message	F1 D9 06 01 03 00 F0 07 00 01 1D
Navigate with GPS only	F1 D9 06 0C 04 00 01 00 00 00 17 A0
Navigate with BeiDou system only	F1 D9 06 0C 04 00 04 00 00 00 1A AC
Navigate with GPS+ BeiDou system	F1 D9 06 0C 04 00 05 00 00 00 1B B0
Query firmware version <sup>[1]</sup>	F1 D9 0A 04 00 00 0E 34

\* [1] Firmware version will show as Hex mode too.

\* [2] Add 0D 0A at the end of command.

## 8.3 Mode Configuration

### 8.3.1 CFG-SIMPLERST

Configure soft reset (as system command, there is NO ACK);

F1 D9 06 40 01 00 00 47 21

Configure a cold start (as system command, there is NO ACK);

F1 D9 06 40 01 00 01 48 22

Configure a warm start (as system command, there is NO ACK);

F1 D9 06 40 01 00 02 49 23

Configure a hot start (as system command, there is NO ACK);

F1 D9 06 40 01 00 03 4A 24

Configure GNSS stop (if successful, it would return ACK, else return NAK);

F1 D9 06 40 01 00 10 57 31

Configure GNSS start (if successful, it would return ACK, else return NAK);

F1 D9 06 40 01 00 11 58 32

Configure Clear All TRK Channels (if successful, it would return ACK, else return NAK);

F1 D9 06 40 01 00 80 C7 A1

CFG-SLEEP

Set GNSS task to deep sleep for 5000 ms;

F1 D9 06 41 05 00 88 13 00 00 01 E8 56

CFG-PWRCTL

Poll message of power control;

F1 D9 06 42 00 00 13 3F

Set receiver into cyclic sleep mode;

F1 D9 06 42 14 00 00 05 00 00 B8 0B 00 00 60 EA 00 00 D0 07 00 00 00 00 00 00 45 F9





## 9 PRODUCT PACKAGING AND HANDLING

### 9.1 Packaging

#### 9.1.1 Packaging Notes

TAU1114 GNSS module is a Moisture Sensitive Device (MSD) and Electrostatic Sensitive Device (ESD). During the packing and shipping, it is strictly required to take appropriate MSD handling instructions and precautions. The table below shows the general packing hierarchy for the standard shipment.

**Table 27 Packing hierarchy**

Module	Reel	Sealed bag	Shipping carton
			

#### 9.1.2 Tape and Reel

TAU1114 modules are delivered as hermetically sealed, reeled tapes in order to enable efficient production, production lot set-up and tear-down. The figure below shows the tape dimensions.

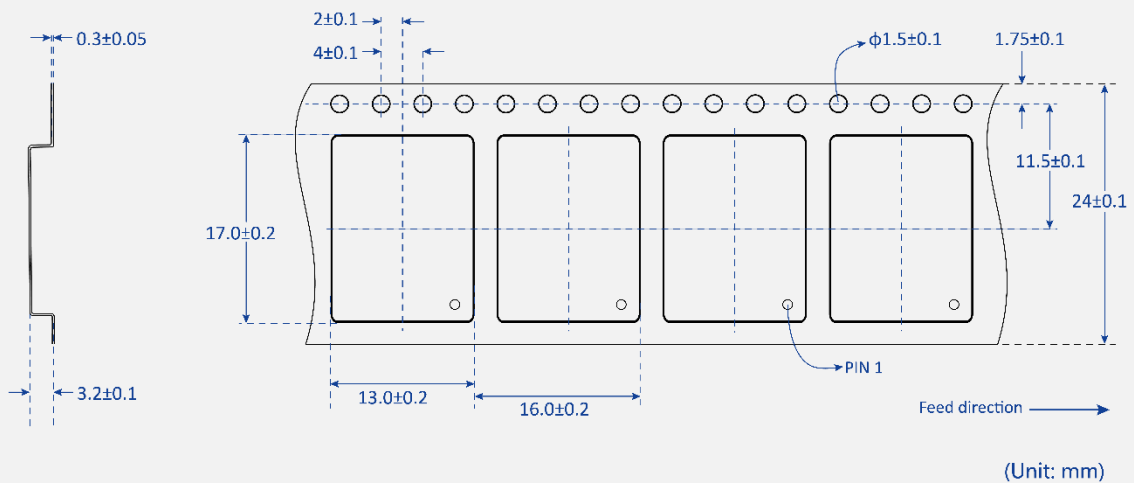

**Figure 8 Tape dimensions**

The TAU1114 modules are deliverable in quantities of 1000 pcs on a reel. The figure below shows the dimensions of reel for TAU1114.

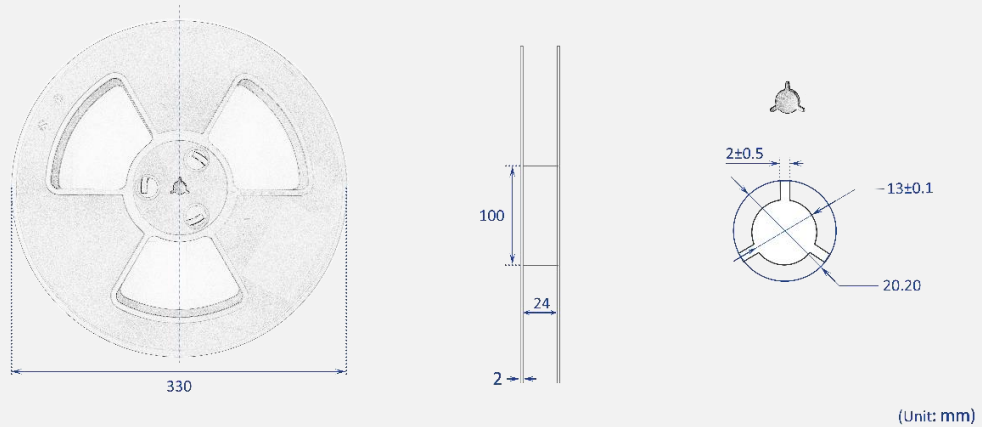

**Figure 9 Reel dimensions**

### 9.1.3 Shipment Packaging

The reels of TAU1114 are packed in the sealed bags and shipped by shipping cartons. Up to five sealed bags (5000 pcs in total) can be packed in one shipping carton.

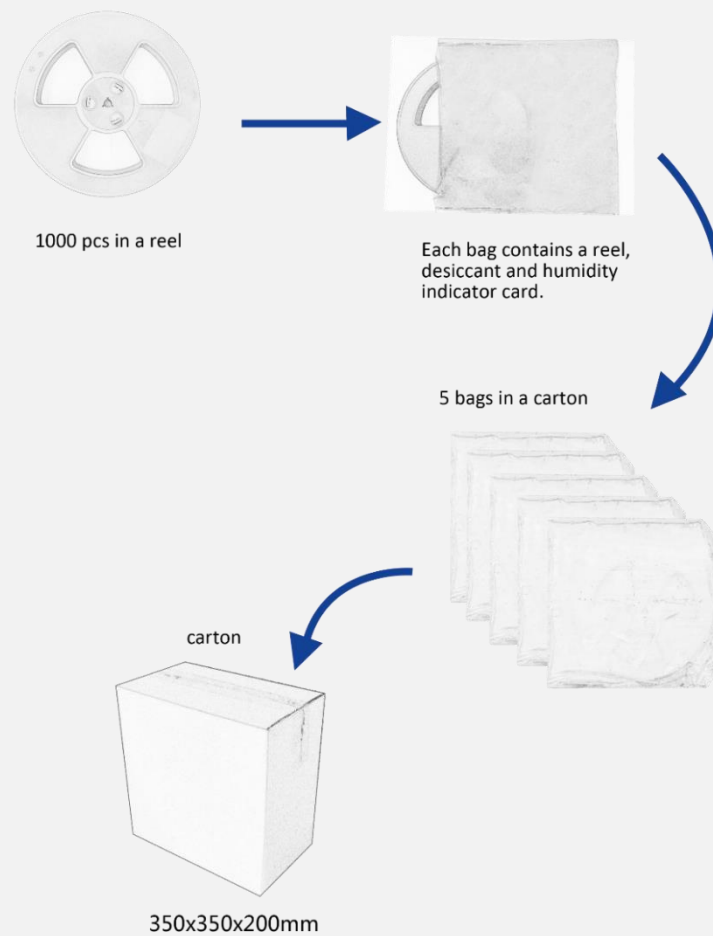

**Figure 10 Packaging**

## 9.2 Storage

In order to prevent moisture intake and protect against electrostatic discharge, TAU1114 is packaged together with a humidity indicator card and desiccant to absorb humidity.

## 9.3 Handling

### 9.3.1 ESD Handling Precautions

The TAU1114 module that contains highly sensitive electronic circuitry is Electrostatic Sensitive Device (ESD). Observe precautions for handling! Failure to observe these precautions may result in severe damage to the GNSS module!

- Unless there is a galvanic coupling between the local GND (i.e. the workbench) and the PCB GND, then the first point of contact when handling the PCB must always be between the local GND and PCB GND.
- Before mounting an antenna patch, connect ground of the device.
- When handling the RF pin, do not come into contact with any charged capacitors and be careful when contacting materials that can develop charges (e.g. patch antenna ~10 pF, coax cable ~50 - 80 pF/m, soldering iron ...)
- To prevent electrostatic discharge through the RF input, do not touch any exposed antenna area. If there is any risk that such exposed antenna area is touched in non ESD protected work area, implement proper ESD protection measures in the design.
- When soldering RF connectors and patch antennas to the receiver's RF pin, make sure to use an ESD safe soldering iron (tip).



### 9.3.2 ESD Protection Measures

This series of GNSS positioning modules is sensitive to static electricity. Whenever handling the module, particular care must be exercised to reduce the risk of electrostatic charges. In addition to standard ESD safety practices, the following measures should be taken into account.

- Adds ESD Diodes to the RF input part to prevent electrostatics discharge.
- Do not touch any exposed antenna area.
- Adds ESD Diodes to the UART interface.

### 9.3.3 Moisture Sensitivity Level

The Moisture Sensitivity Level (MSL) of the GNSS modules is MSL3.

## 10 LABELING AND ORDERING INFORMATION

Labeling and ordering information help customers get more about Allystar products.

### 10.1 Labeling

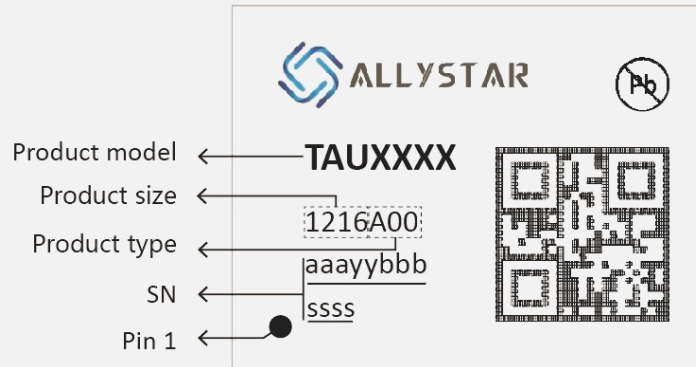

Symbol	Explanation	Instance
TAUXXXX	Product model	TAU1114
1216A00	1216 represents the product size.	1216A00
	A00 means the product type.	
aaayybbbSSSS	Serial number	351190010001

### 10.2 Ordering info

**Table 28 Ordering codes**

Ordering No.	Product information
TAU1114-1216A00E <sup>[1]</sup>	Concurrent GNSS LCC Module, TCXO, Flash, 12.2*16 mm, 1000 pieces/reel.

\* [1] See Table 1 for the GNSS systems supported.

## 11 RELATED DOCUMENTS

- [1] Recommended Reflow Profile
- [2] Satrack User Manual
- [3] Allystar Common Commands
- [4] GNSS Protocol Specification

## 12 REVISION HISTORY

Revision	Date	Reviser	Status/Comments
V1.0	2022-07	Cao Min	Initial release.
V1.1	2022-08	Cao Min	Updates the total GNSS channels in Table 2
V1.2	2022-08	Cao Min	Adds the antenna bias voltage in Table 8





[www.allystar.com](http://www.allystar.com)



[info.gnss@allystar.com](mailto:info.gnss@allystar.com)



## Headquarters

Allystar Technology (Shenzhen) Co., Ltd.

Address: 201-2, 2F, Tower F, Xinghe World, No.1, Yabao Road, LongGang District, Shenzhen City, Guangdong Province, China.

## Calgary Office

Allystar Technology (Canada) Ltd.

Address: Unit 288, 3553 31 Street NW Calgary, Alberta, Canada T2L 2K7

